

Specifications

- Current rating:3A AC,DC
- Voltage rating:250V AC,DC
- Temperature range:-25°C~+85°C
- Contact resistance:10mΩMax.
- Insulation resistance:1000MΩMin.
- Withstanding voltage:1000V AC/minute
- *Compliant with RoHS and REACH*
- *Meet the HF/Halogen Free,need to customize*
- *Contact HDGC for details*

Assembly layout

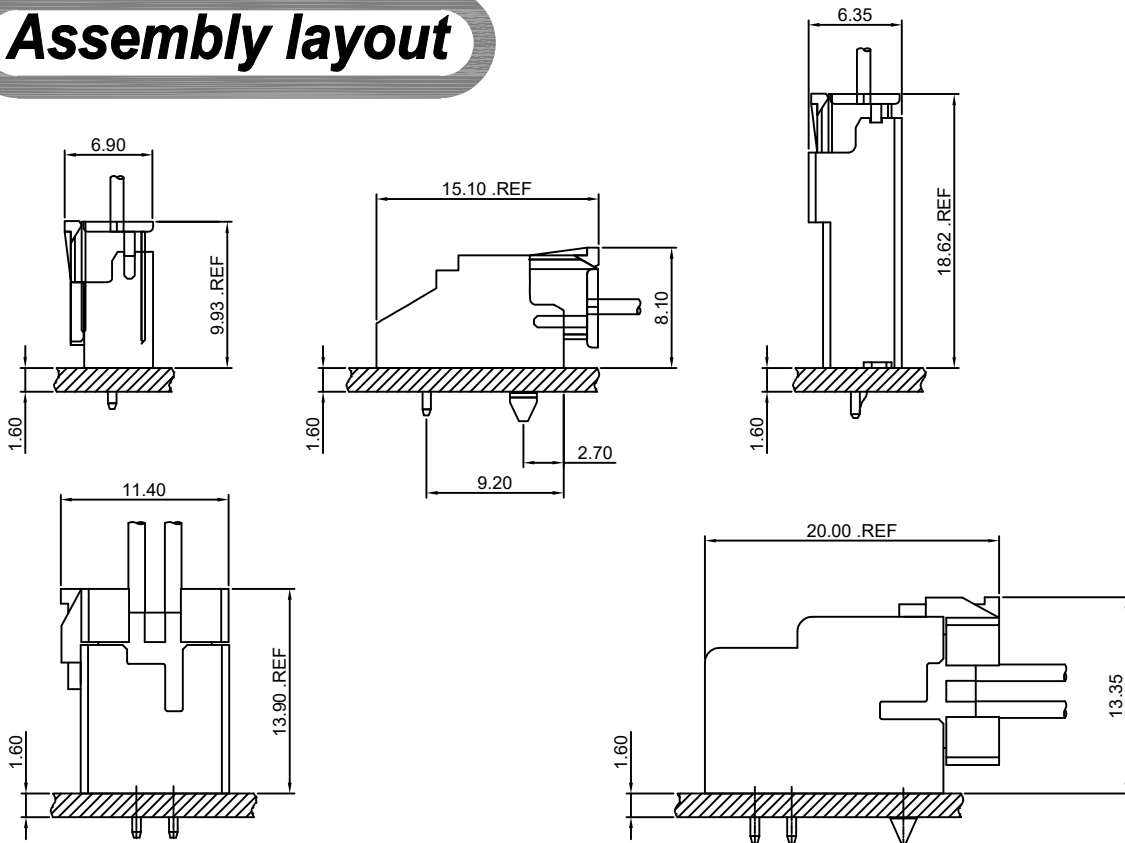



HDGC2523 Series 2.50mm (.098") Pitch Wire to Board and Wire to Wire Connector

HDGC2523-T

2.50mm Pitch Crimp Terminal

Reference Informations:

*Used in HDGC2523H,HA-XP ,HDGC2523H-2xXP series Housing

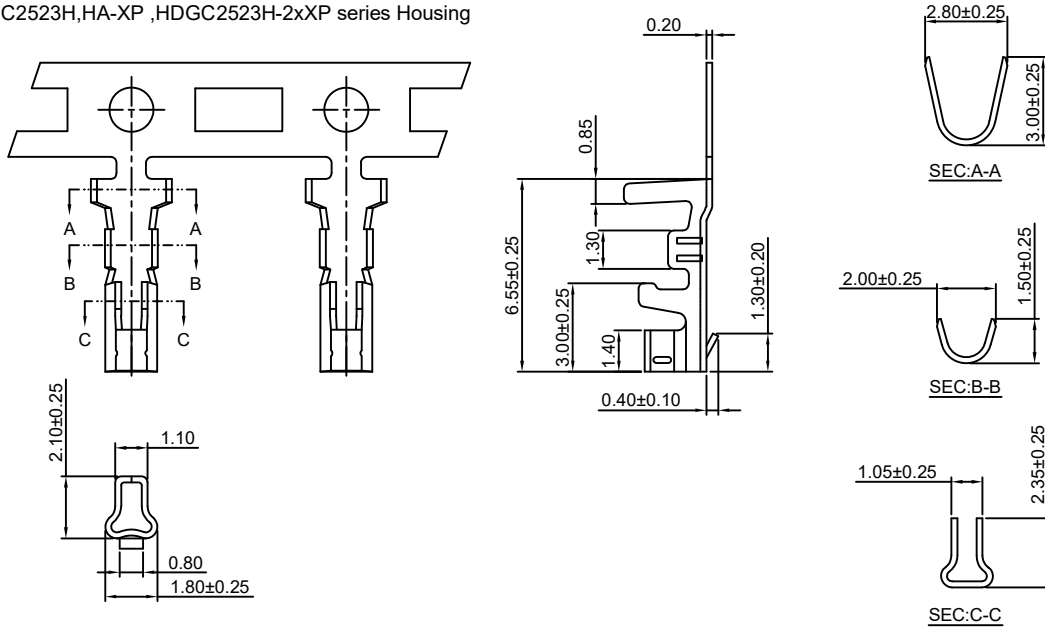

Ordering information & Specifications:

Unit:mm

Part NO	Wire Range	Insulation O.D.	Material	Finish	Qty/reel
HDGC2523-TP	AWG#22-#26	1.90mm(max)	Phosphor Bronze	Tin over Nickel	10,000 PCS
HDGC2523-GP	AWG#22-#26	1.90mm(max)	Phosphor Bronze	Gold over Nickel	10,000 PCS

Optional Gold plating available but MOQ requested

HDGC2523-T-L

2.50mm Pitch Crimp Terminal

Reference Informations:

*Used in HDGC2523H,HA-XP ,HDGC2523H-2xXP series Housing

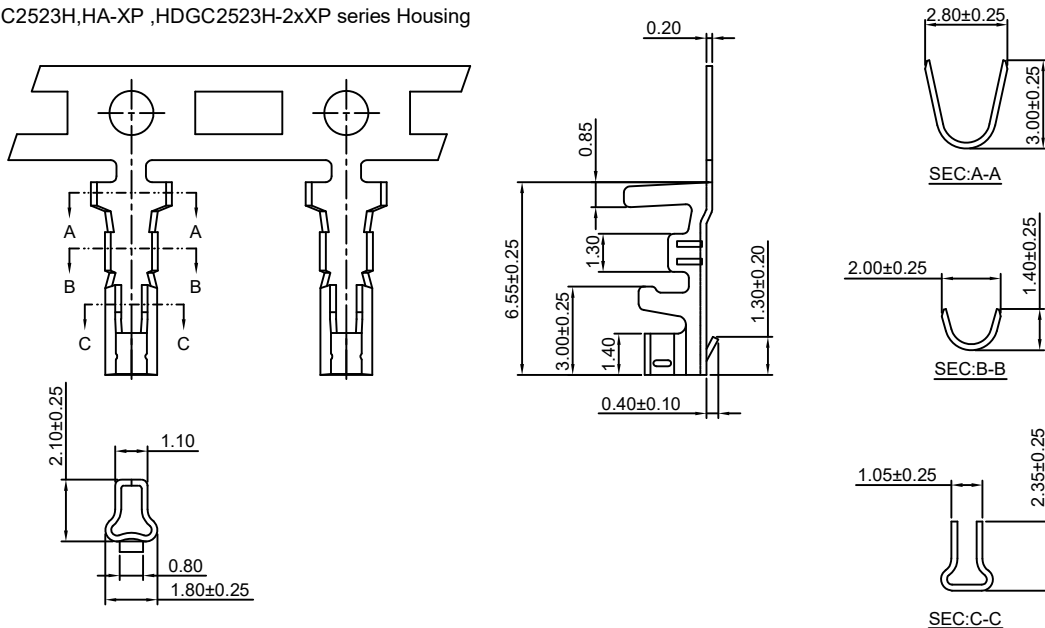

Ordering information & Specifications:

Unit:mm

Part NO	Wire Range	Insulation O.D.	Material	Finish	Qty/reel
HDGC2523-TP-L	AWG#22-#28	1.90mm(max)	Phosphor Bronze	Tin over Nickel	10,000 PCS
HDGC2523-GP-L	AWG#22-#28	1.90mm(max)	Phosphor Bronze	Gold over Nickel	10,000 PCS

Optional Gold plating available but MOQ requested



HDGC2523 Series 2.50mm (.098") Pitch Wire to Board and Wire to Wire Connector

HDGC2523-T-H

2.50mm Pitch Crimp Terminal

Reference Informations:

*Used in HDGC2523H,HA-XP ,HDGC2523H-2xXP series Housing

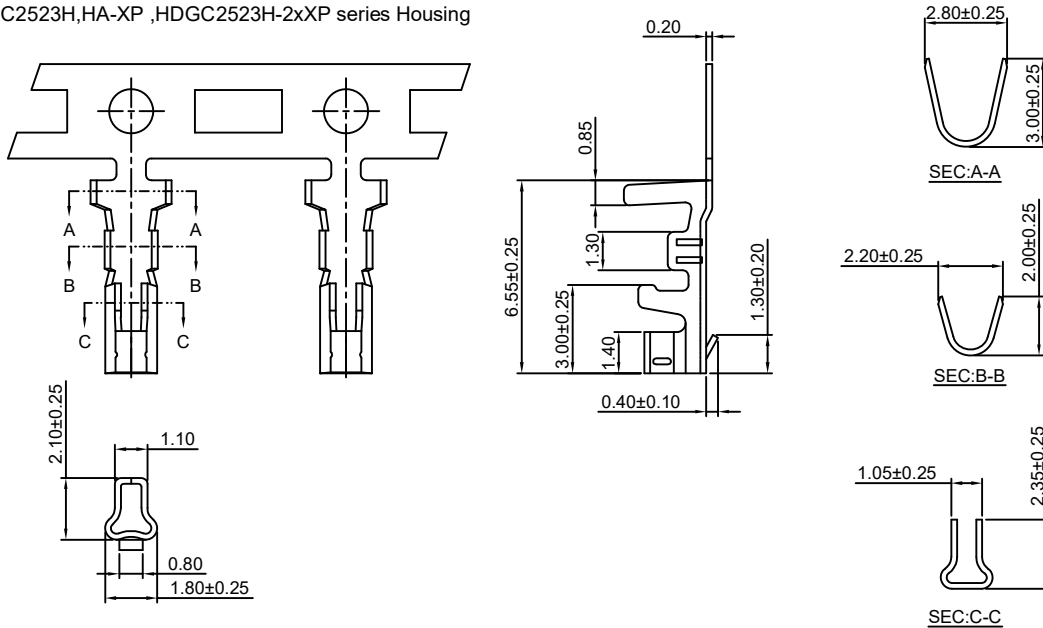

Ordering information & Specifications:

Unit:mm

Part NO	Wire Range	Insulation O.D.	Material	Finish	Qty/reel
HDGC2523-TP-H	AWG#20-#24	1.90mm(max)	Phosphor Bronze	Tin over Nickel	10,000 PCS
HDGC2523-GP-H	AWG#20-#24	1.90mm(max)	Phosphor Bronze	Gold over Nickel	10,000 PCS

Optional Gold plating available but MOQ requested

HDGC2523M-T

2.50mm Pitch Crimp Terminal

Reference Informations:

*Used in HDGC2523HMA-XP series Housing

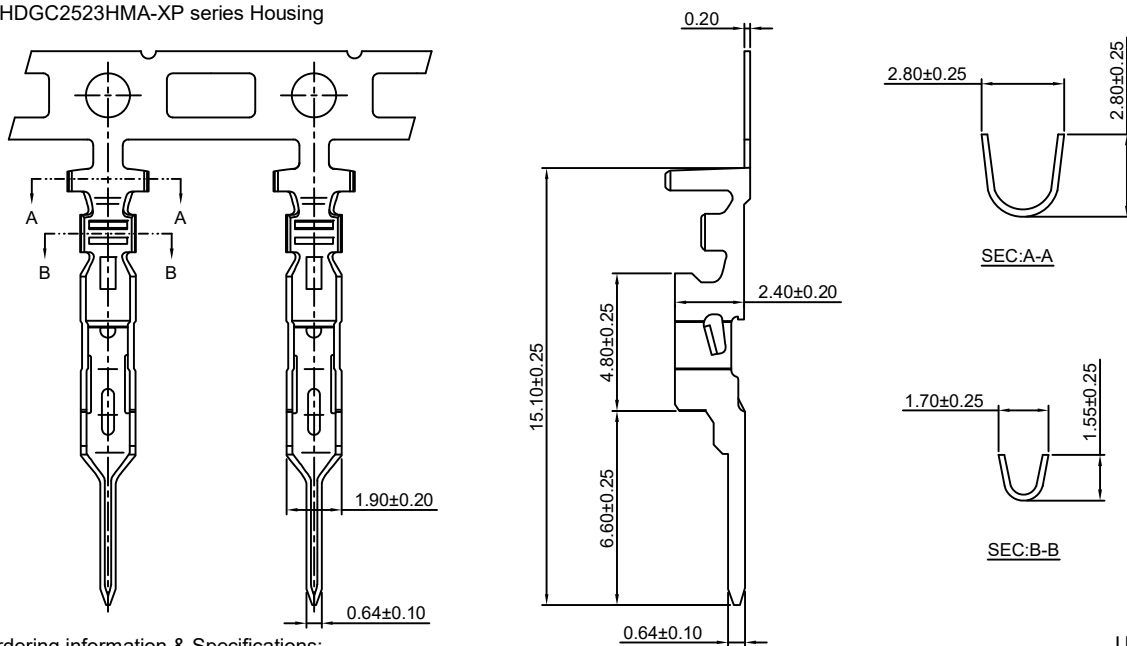

Ordering information & Specifications:

Unit:mm

Part NO	Wire Range	Insulation O.D.	Material	Finish	Qty/reel
HDGC2523M-TP	AWG#22-#28	1.90mm(max)	Phosphor Bronze	Tin over Nickel	7,000 PCS
HDGC2523M-GP	AWG#22-#28	1.90mm(max)	Phosphor Bronze	Gold over Nickel	7,000 PCS

Optional Gold plating available but MOQ requested



HDGC2523 Series 2.50mm (.098") Pitch Wire to Board and Wire to Wire Connector

HDGC2523-T-A

2.50mm Pitch Crimp Terminal

Reference Informations:

*Used in HDGC2523HA--2xXP series Housing

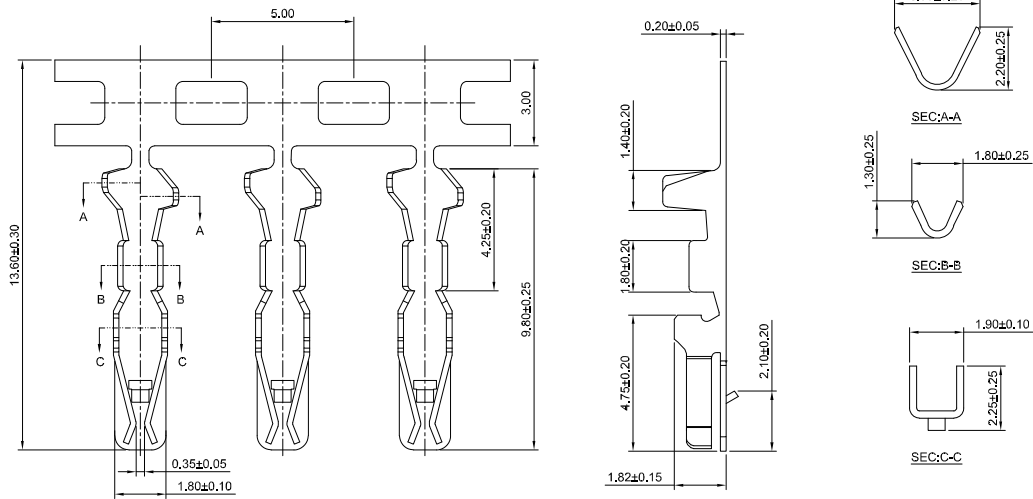

Ordering information & Specifications:

Unit:mm

Part NO	Wire Range	Insulation O.D.	Material	Finish	Qty/reel
HDGC2523-TP-A	AWG#22-#30	1.90mm(max)	Phosphor Bronze	Tin over Nickel	13,000 PCS
HDGC2523-GP-A	AWG#22-#30	1.90mm(max)	Phosphor Bronze	Gold over Nickel	13,000 PCS

Optional Gold plating available but MOQ requested



HDGC2523 Series 2.50mm (.098") Pitch Wire to Board and Wire to Wire Connector

HDGC2523H-XP

2.50mm Pitch Housing

Reference Informations:

- *Material: Nylon 66, UL94V-0
- *Suitable HDGC2523-T series Terminal
- *Mates with HDGC2523WV, WV-F-XP(-H), HDGC2523WR, WR-F-XP, WV-S-XP, WVT-XP(-H), HDGC2523WVT-F-XP(-H) series Wafer
- *Color: White

Ordering Information:

HDGC2523H-XP - *** - **
 1 2 3

- Part No.
- Material:
 (blank): Nylon 66, UL94V-0
 GWT: Nylon 66, UL94V-0, GWT 750 °C
- Color:
 (Blank): White
 RD: Red
 YL: Yellow
 BL: Blue
 BK: Black
 GN: Green
 IV: Ivory
 LE: Light blue
 OR: Orange
 GY: Gray
 PK: Pink
 BR: Brown
 VI: Violet
 LY: Lemon yellow
 VY: Vivid yellow

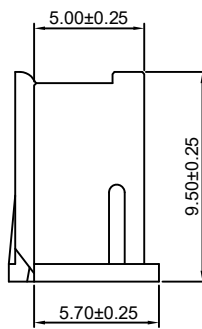
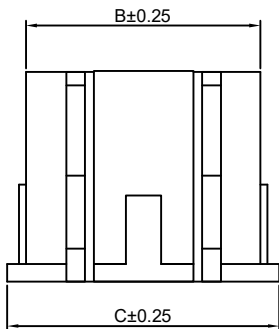
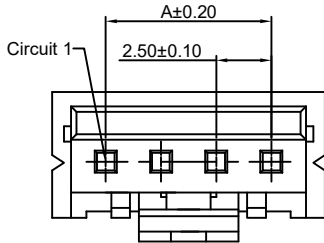
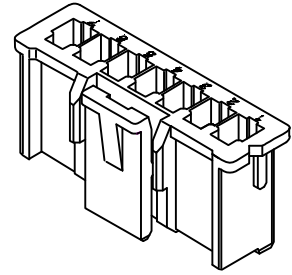

Ordering Information & Dimensions:

PART NO.	Dimensions		
	A	B	C
2P	2.50	5.64	7.30
3P	5.00	8.14	9.80
4P	7.50	10.64	12.30
5P	10.00	13.14	14.80
6P	12.50	15.64	17.30
7P	15.00	18.14	19.80
8P	17.50	20.64	22.30
9P	20.00	23.14	24.80
10P	22.50	25.64	27.30
11P	25.00	28.14	29.80
12P	27.50	30.64	32.30
13P	30.00	33.14	34.80
14P	32.50	35.64	37.30
15P	35.00	38.14	39.80

Unit: mm

HDGC2523HA-XP

2.50mm Pitch Housing

Reference Informations:

- *Material: Nylon 66, UL94V-0
- *Suitable HDGC2523-T series Terminal
- *Mates with HDGC2523HMA-XP series Housing and HDGC2523SA-XP series Seal and HDGC2523WV, WV-F-XP(-H), WR, WR-F-XP, WV-S-XP, HDGC2523WVT-XP(-H), HDGC2523WVT-F-XP(-H) series Wafer
- *Color: White

Ordering Information:

HDGC2523HA-XP - *** - **
 1 2 3

- Part No.
- Material:
 (blank): Nylon 66, UL94V-0
 GWT: Nylon 66, UL94V-0, GWT 750 °C
- Color:
 (blank) : White
 BK: Black
 RD: Red
 BL: Blue
 LY: Lemon yellow

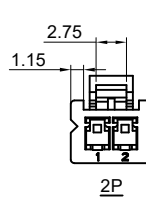
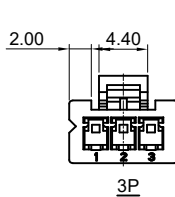
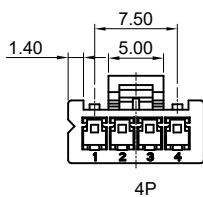
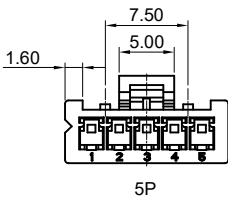
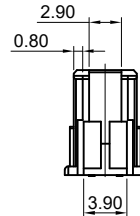
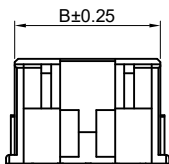
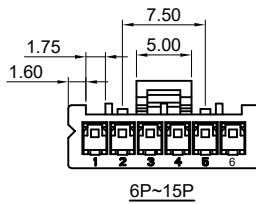
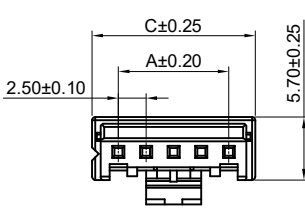

Ordering Information & Dimensions:

PART NO.	Dimensions		
	A	B	C
2P	2.50	5.70	7.30
3P	5.00	8.20	9.80
4P	7.50	10.70	12.30
5P	10.00	13.20	14.80
6P	12.50	15.70	17.30
7P	15.00	18.20	19.80
8P	17.50	20.70	22.30
9P	20.00	23.20	24.80
10P	22.50	25.70	27.30
11P	25.00	28.20	29.80
12P	27.50	30.70	32.30
13P	30.00	33.20	34.80
14P	32.50	35.70	37.30
15P	35.00	38.20	39.80

Unit: mm



HDGC2523 Series 2.50mm (.098") Pitch Wire to Board and Wire to Wire Connector

HDGC2523HMA-XP

2.50mm Pitch Housing

Reference Informations:

- *Material:Nylon 66,UL94V-0
- *Suitable HDGC2523M-T series Terminal
- *Mates with HDGC2523H,HA-XP series Housing
- *Color:White

Ordering Information:

HDGC2523HMA-XP - *** - **
 1 2 3

- 1.Part No.
- 2.Material:
 (blank):Nylon 66,UL94V-0
 GWT:Nylon 66,UL94V-0 ,GWT 750 °C
- 3.Color:
 (Blank):White
 RD:Red
 YL:Yellow
 BL:Blue
 BK:Black
 GN:Green
 OR:Orange
 GY:Gray
 PK:Pink
 BR:Brown
 VI:Violet

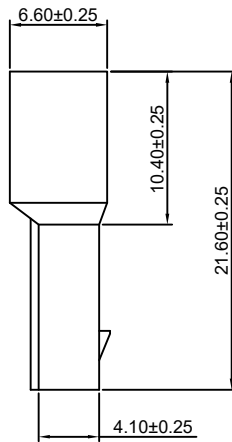
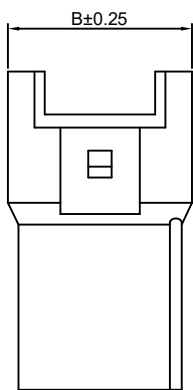
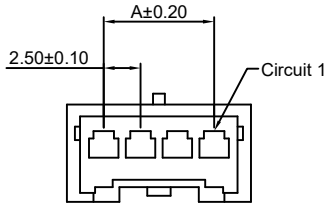
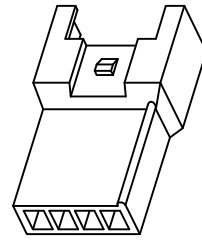

Ordering Information & Dimensions:

PART NO.	Dimensions	
	A	B
2P	2.50	7.50
3P	5.00	10.00
4P	7.50	12.50
5P	10.00	15.00
6P	12.50	17.50
7P	15.00	20.00
8P	17.50	22.50
9P	20.00	25.00
10P	22.50	27.50
11P	25.00	30.00
12P	27.50	32.50
13P	30.00	35.00
14P	32.50	37.50
15P	35.00	40.00

Unit: mm

HDGC2523SA-XP

2.50mm Pitch Seal

Reference Informations:

- *Material:Nylon 66,UL94V-0
- *Mates with HDGC2523HA-XP series Housing
- *Color:Ivory

Ordering Information:

HDGC2523SA-XP - ***
 1 2

- 1.Part No.
- 2.Material:
 (blank):Nylon 66,UL94V-0
 GWT:Nylon 66,UL94V-0 ,GWT 750 °C

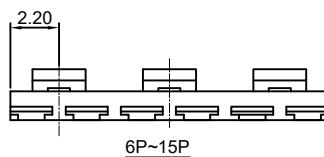
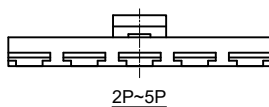
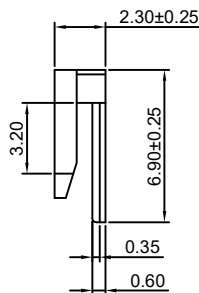
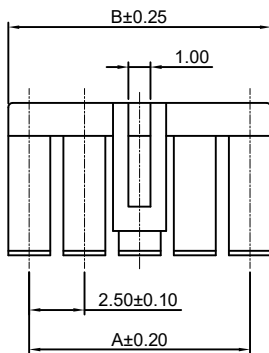

Ordering Information & Dimensions:

PART NO.	Dimensions	
	A	B
2P	2.50	4.40
3P	5.00	6.90
4P	7.50	9.40
5P	10.00	11.90
6P	12.50	14.40
7P	15.00	16.90
8P	17.50	19.40
9P	20.00	21.90
10P	22.50	24.40
11P	25.00	26.90
12P	27.50	29.40
13P	30.00	31.90
14P	32.50	34.40
15P	35.00	36.90

Unit: mm



HDGC2523 SERIES



HDGC2523 Series 2.50mm (.098") Pitch Wire to Board and Wire to Wire Connector

HDGC2523HA-2xXP

2.50mm Pitch Housing

Reference Informations:

- *Material:Nylon 66,UL94V-0
- *Suitable HDGC2523-T-A series Terminal
- *Mates with HDGC2523WVA/WRA-2xXP series Wafer
- *Color:White

Ordering Information:

HDGC2523HA-2xXP - $\frac{***}{1}$ - $\frac{**}{2}$ - $\frac{**}{3}$

- 1.Part No.
- 2.Material:
(blank):Nylon 66,UL94V-0
GWT:Nylon 66,UL94V-0,GWT 750 °C
- 3.Color:
(Blank):White
RD:Red
YL:Yellow
BL:Blue
BK:Black
GN:Green
IV:Ivory
LE:Light blue
OR:Orange
GY:Gray
PK:Pink
BR:Brown
VI:Violet
LY:Lemon yellow
VY:Vivid yellow

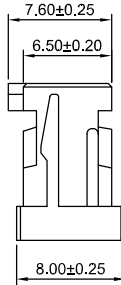
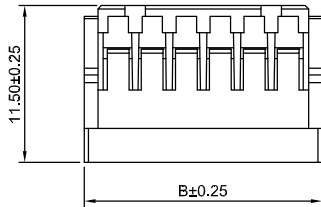
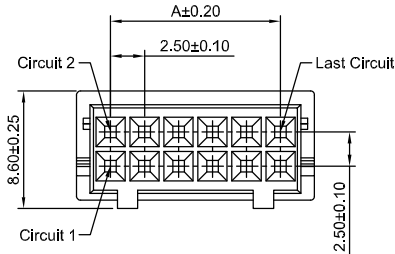
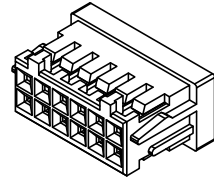

Ordering Information & Dimensions:

PART NO.	Dimensions	
	A	A
2x2P	2.50	7.50
2x3P	5.00	10.00
2x4P	7.50	12.50
2x5P	10.00	15.00
2x6P	12.50	17.50
2x7P	15.00	20.00
2x8P	17.50	22.50
2x9P	20.00	25.00
2x10P	22.50	27.50
2x11P	25.00	30.00
2x12P	27.50	32.50
2x13P	30.00	35.00
2x14P	32.50	37.50
2x15P	35.00	40.00
2x16P	37.50	42.50
2x17P	40.00	45.00
2x18P	42.50	47.50
2x19P	45.00	50.00
2x20P	47.50	52.50

Unit: mm



HDGC2523 Series 2.50mm (.098") Pitch Wire to Board and Wire to Wire Connector

HDGC2523WV-XP

2.50mm Pitch 180° Wafer

Reference Informations:

- *Material: Pin: Brass/Tin over Nickel
Insulator: Nylon 66, UL94V-0
- *Mates with HDGC2523H, HA-XP series Housing
- *Color: Ivory

Ordering Information:
HDGC2523WV-XP - *** - ** - **
 1 2 3 4

1. Part No.
2. Material:
 (blank): Nylon 66, UL94V-0
 GWT: Nylon 66, UL94V-0, GWT 750 °C
3. Color:
 (Blank): Ivory
 RD: Red OR: Orange
 YL: Yellow GY: Gray
 BL: Blue PK: Pink
 BK: Black BR: Brown
 GN: Green VI: Violet
 WH: White LY: Lemon yellow
 LE: Light blue VY: Vivid yellow
4. Finish:
 (blank): Tin over Nickel
 G: Gold over Nickel

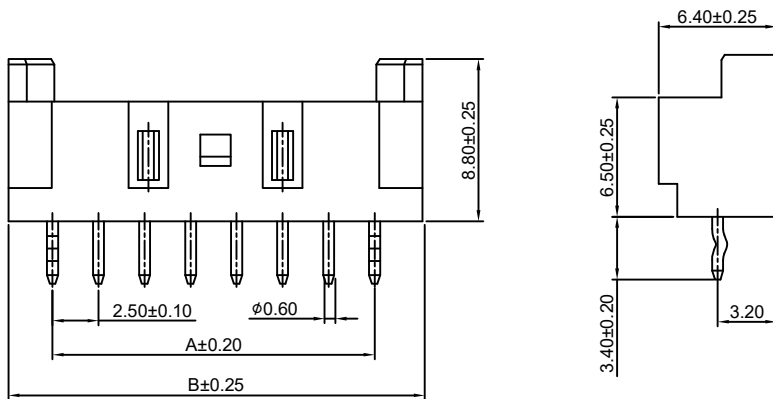
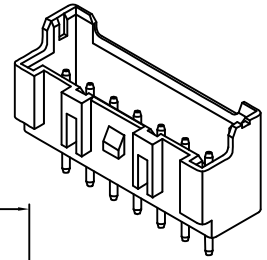
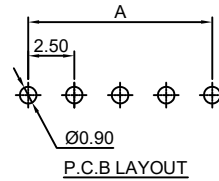
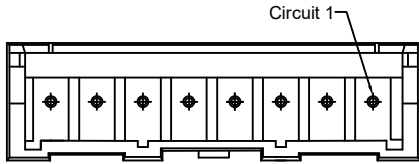

Ordering Information & Dimensions:

PART NO.	Dimensions	
	A	B
2P	2.50	7.50
3P	5.00	10.00
4P	7.50	12.50
5P	10.00	15.00
6P	12.50	17.50
7P	15.00	20.00
8P	17.50	22.50
9P	20.00	25.00
10P	22.50	27.50
11P	25.00	30.00
12P	27.50	32.50
13P	30.00	35.00
14P	32.50	37.50
15P	35.00	40.00

Unit: mm

HDGC2523WR-XP

2.50mm Pitch 90° Wafer

Reference Informations:

- *Material: Pin: Brass/Tin over Nickel
Insulator: Nylon 66, UL94V-0
- *Mates with HDGC2523H, HA-XP series Housing
- *Color: Ivory

Ordering Information:
HDGC2523WR-XP - *** - ** - **
 1 2 3 4

1. Part No.
2. Material:
 (blank): Nylon 66, UL94V-0
 GWT: Nylon 66, UL94V-0, GWT 750 °C
3. Color:
 (Blank): Ivory
 RD: Red OR: Orange
 YL: Yellow GY: Gray
 BL: Blue PK: Pink
 BK: Black BR: Brown
 GN: Green VI: Violet
 WH: White LY: Lemon yellow
 LE: Light blue VY: Vivid yellow
4. Finish:
 (blank): Tin over Nickel
 G: Gold over Nickel

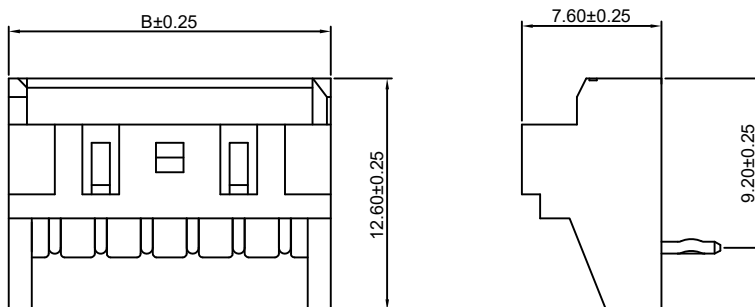
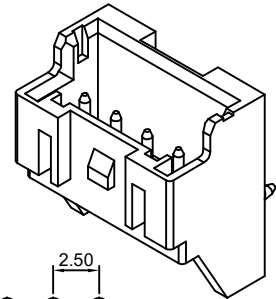
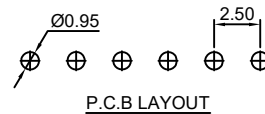
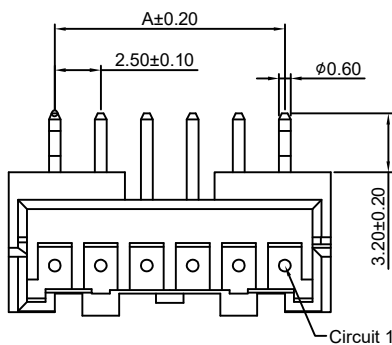

Ordering Information & Dimensions:

PART NO.	Dimensions	
	A	B
2P	2.50	7.50
3P	5.00	10.00
4P	7.50	12.50
5P	10.00	15.00
6P	12.50	17.50
7P	15.00	20.00
8P	17.50	22.50
9P	20.00	25.00
10P	22.50	27.50
11P	25.00	30.00
12P	27.50	32.50
13P	30.00	35.00
14P	32.50	37.50
15P	35.00	40.00

Unit: mm



HDGC2523 Series 2.50mm (.098") Pitch Wire to Board and Wire to Wire Connector

HDGC2523WV-F-XP

2.50mm Pitch 180° Wafer

Reference Informations:

- *Material: Pin: Brass/Tin over Nickel
Insulator: Nylon 66, UL94V-0
- *Mates with HDGC2523H, HA-XP series Housing
- *Color: Ivory

Ordering Information:

HDGC2523WV-F-XP - *** - ** - **
1 2 3 4

1. Part No.
2. Material:
(blank): Nylon 66, UL94V-0
GWT: Nylon 66, UL94V-0, GWT 750 °C
3. Color:
(Blank): Ivory
RD: Red OR: Orange
YL: Yellow GY: Gray
BL: Blue PK: Pink
BK: Black BR: Brown
GN: Green VI: Violet
WH: White LY: Lemon yellow
LE: Light blue VY: Vivid yellow
4. Finish:
(blank): Tin over Nickel
G: Gold over Nickel

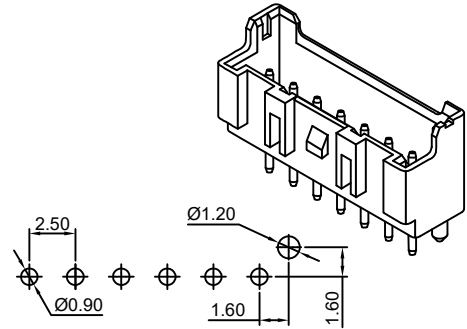
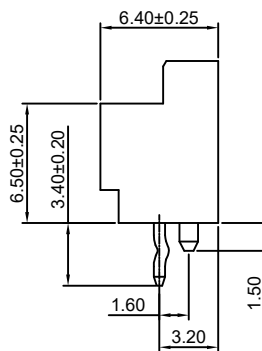
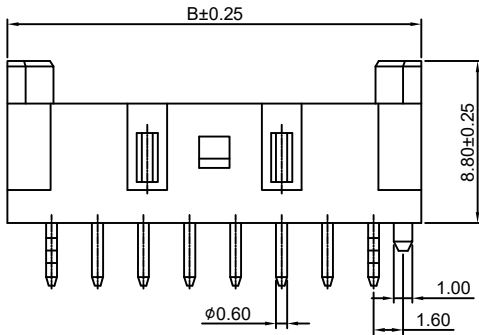
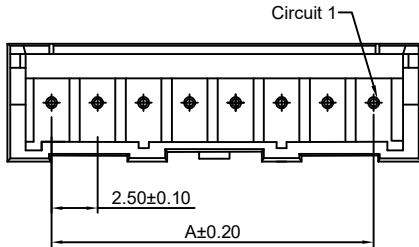

P.C.B LAYOUT

Ordering Information & Dimensions:

PART NO.	Dimensions	
	A	B
2P	2.50	7.50
3P	5.00	10.00
4P	7.50	12.50
5P	10.00	15.00
6P	12.50	17.50
7P	15.00	20.00
8P	17.50	22.50
9P	20.00	25.00
10P	22.50	27.50
11P	25.00	30.00
12P	27.50	32.50
13P	30.00	35.00
14P	32.50	37.50
15P	35.00	40.00

Unit: mm

HDGC2523WR-F-XP

2.50mm Pitch 90° Wafer

Reference Informations:

- *Material: Pin: Brass/Tin over Nickel
Insulator: Nylon 66, UL94V-0
- *Mates with HDGC2523H, HA-XP series Housing
- *Color: Ivory

Ordering Information:

HDGC2523WR-F-XP - *** - ** - **
1 2 3 4

1. Part No.
2. Material:
(blank): Nylon 66, UL94V-0
GWT: Nylon 66, UL94V-0, GWT 750 °C
3. Color:
(Blank): Ivory
RD: Red OR: Orange
YL: Yellow GY: Gray
BL: Blue PK: Pink
BK: Black BR: Brown
GN: Green VI: Violet
WH: White LY: Lemon yellow
LE: Light blue VY: Vivid yellow
4. Finish:
(blank): Tin over Nickel
G: Gold over Nickel

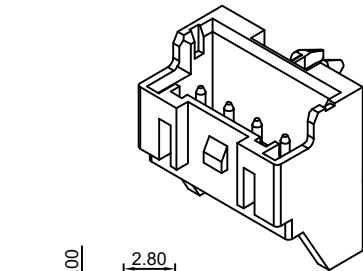
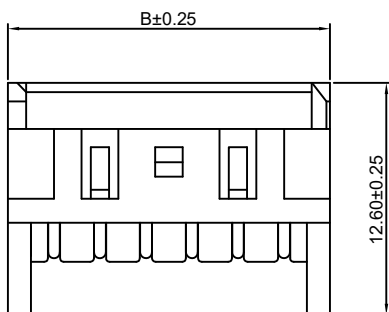
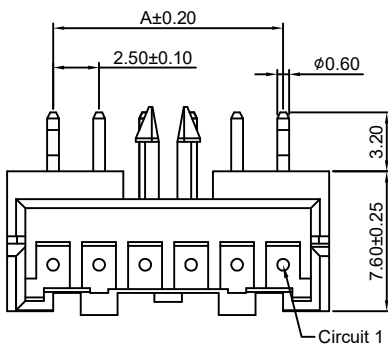

P.C.B LAYOUT

Ordering Information & Dimensions:

PART NO.	Dimensions	
	A	B
2P	2.50	7.50
3P	5.00	10.00
4P	7.50	12.50
5P	10.00	15.00
6P	12.50	17.50
7P	15.00	20.00
8P	17.50	22.50
9P	20.00	25.00
10P	22.50	27.50
11P	25.00	30.00
12P	27.50	32.50
13P	30.00	35.00
14P	32.50	37.50
15P	35.00	40.00

Unit: mm



HDGC2523 Series 2.50mm (.098") Pitch Wire to Board and Wire to Wire Connector

HDGC2523WV-XP-H

2.50mm Pitch 180° Wafer-High box type

Reference Informations:

- *Material: Pin: Brass/Tin over Nickel
Insulator: Nylon 66, UL94V-0
- *Mates with HDGC2523H, HA-XP series Housing
- *Color: Ivory

Ordering Information:
HDGC2523WV-XP-H - *** - ** - **
1 2 3 4

1. Part No.
2. Material:
(blank): Nylon 66, UL94V-0
GWT: Nylon 66, UL94V-0, GWT 750 °C
3. Color:
(blank): Ivory
BK: Black
RD: Red
YL: Yellow
GN: Green
4. Finish:
(blank): Tin over Nickel
G: Gold over Nickel

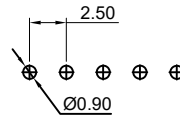
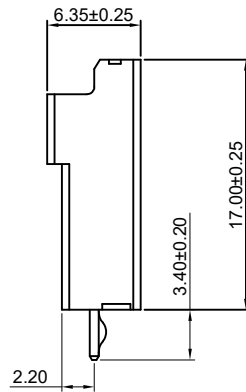
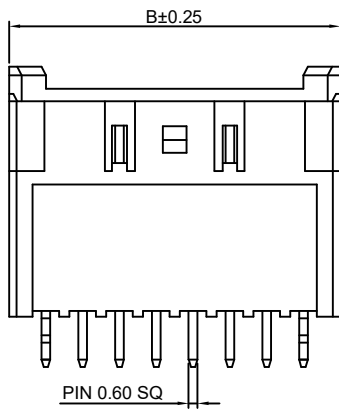
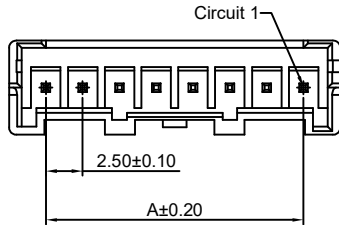

P.C.B LAYOUT

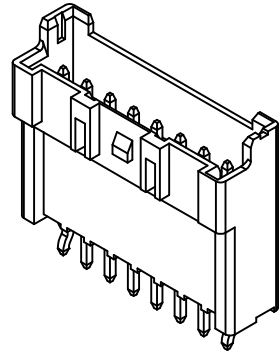

Ordering Information & Dimensions:

PART NO.	Dimensions	
	A	B
2P	2.50	7.50
3P	5.00	10.00
4P	7.50	12.50
5P	10.00	15.00
6P	12.50	17.50
7P	15.00	20.00
8P	17.50	22.50
9P	20.00	25.00
10P	22.50	27.50
11P	25.00	30.00
12P	27.50	32.50
13P	30.00	35.00
14P	32.50	37.50
15P	35.00	40.00

Unit: mm

HDGC2523WV-F-XP-H

2.50mm Pitch 180° Wafer-High box type

Reference Informations:

- *Material: Pin: Brass/Tin over Nickel
Insulator: Nylon 66, UL94V-0
- *Mates with HDGC2523H, HA-XP series Housing
- *Color: Ivory

Ordering Information:
HDGC2523WV-F-XP-H - *** - ** - **
1 2 3 4

1. Part No.
2. Material:
(blank): Nylon 66, UL94V-0
GWT: Nylon 66, UL94V-0, GWT 750 °C
3. Color:
(blank): Ivory
BK: Black
RD: Red
YL: Yellow
GN: Green
4. Finish:
(blank): Tin over Nickel
G: Gold over Nickel

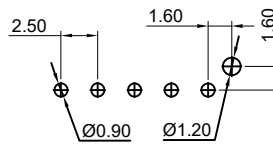
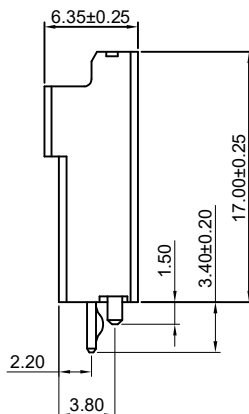
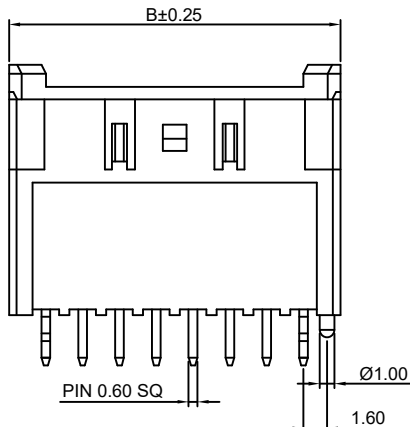
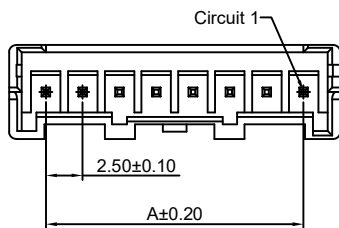

P.C.B LAYOUT

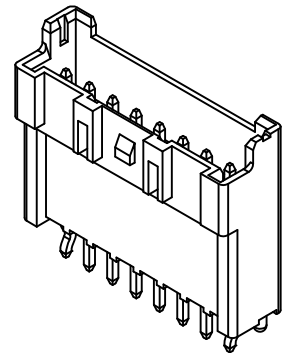

Ordering Information & Dimensions:

PART NO.	Dimensions	
	A	B
2P	2.50	7.50
3P	5.00	10.00
4P	7.50	12.50
5P	10.00	15.00
6P	12.50	17.50
7P	15.00	20.00
8P	17.50	22.50
9P	20.00	25.00
10P	22.50	27.50
11P	25.00	30.00
12P	27.50	32.50
13P	30.00	35.00
14P	32.50	37.50
15P	35.00	40.00

Unit: mm



HDGC2523 Series 2.50mm (.098") Pitch Wire to Board and Wire to Wire Connector

HDGC2523WV-S-XP

2.50mm Pitch 180° Wafer - SMT TYPE

Reference Informations:

- *Material: Pin: Brass/Tin over Nickel
Insulator: Nylon 9T, UL94V-0
- *Mates with HDGC2523H, HA-XP series Housing
- *Color: Ivory

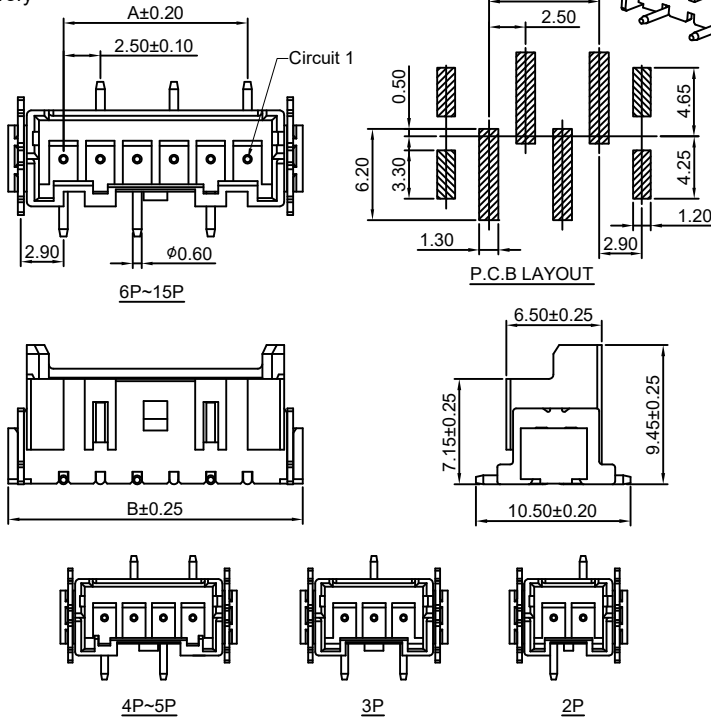

Ordering Information:

HDGC2523WV-S-XP - $\frac{***}{1} - \frac{**}{2} - \frac{**}{3} - \frac{**}{4}$

- Part No.
- Material:
(blank): Nylon 66, UL94V-0
GWT: Nylon 66, UL94V-0, GWT 750°C
- Color:
(Blank): Ivory
RD: Red OR: Orange
BL: Blue BK: Black
GN: Green LY: Lemon yellow
- Finish:
(blank): Tin over Nickel
G: Gold over Nickel

Ordering Information & Dimensions:

PART NO.	Dimensions	
	A	B
2P	2.50	10.00
3P	5.00	12.50
4P	7.50	15.00
5P	10.00	17.50
6P	12.50	20.00
7P	15.00	22.50
8P	17.50	25.00
9P	20.00	27.50
10P	22.50	30.00
11P	25.00	32.50
12P	27.50	35.00
13P	30.00	37.50
14P	32.50	40.00
15P	35.00	42.50

Unit: mm

HDGC2523H-2xXP

2.50mm Pitch Dual Row Housing

Reference Informations:

- *Material: Nylon 66, UL94V-0
- *Suitable HDGC2523-T series Terminal
- *Mates with HDGC2523WV, WV-F-2xXP series Wafer
- *Color: White

Ordering Information:

HDGC2523H-2xXP - $\frac{***}{1} - \frac{**}{2} - \frac{**}{3}$

- Part No.
- Material:
(blank): Nylon 66, UL94V-0
GWT: Nylon 66, UL94V-0, GWT 750°C
- Color:
(Blank): White
BK: Black
RD: Red
BL: Blue
GN: Green
PK: Pink
LY: Lemon yellow

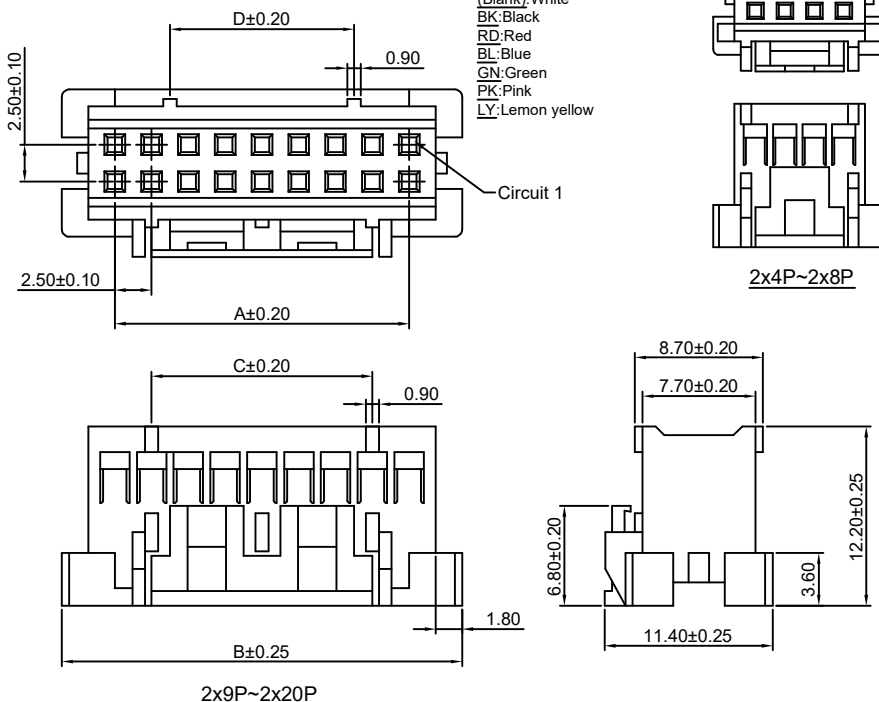

Ordering Information & Dimensions:

PART NO.	Dimensions			
	A	B	C	D
2x4P	7.50	14.70	9.10	----
2x5P	10.00	17.20	7.50	----
2x6P	12.50	19.70	10.00	----
2x7P	15.00	22.20	12.50	----
2x8P	17.50	24.70	15.00	----
2x9P	20.00	27.20	15.00	12.50
2x10P	22.50	29.70	17.50	15.00
2x11P	25.00	32.20	20.00	17.50
2x12P	27.50	34.70	22.50	20.00
2x13P	30.00	37.20	25.00	22.50
2x14P	32.50	39.70	27.50	25.00
2x15P	35.00	42.20	30.00	27.50
2x16P	37.50	44.70	32.50	30.00
2x17P	40.00	47.20	35.00	32.50
2x18P	42.50	49.70	37.50	35.00
2x19P	45.00	52.20	40.00	37.50
2x20P	47.50	54.70	42.50	40.00

Unit: mm



HDGC2523 Series 2.50mm (.098") Pitch Wire to Board and Wire to Wire Connector

HDGC2523WV(-F)-2xXP

2.50mm Pitch Dual Row 180° Wafer

Reference Informations:

- *Material: Pin: Brass/Tin over Nickel
Insulator: Nylon 66, UL94V-0
- *Mates with HDGC2523H-2xXP series Housing
- *Color: Ivory

Ordering Information:
HDGC2523WV(-F)-2xXP - *** - **
1 2 3

- Part No.
- Material:
(blank): Nylon 66, UL94V-0
GWT: Nylon 66, UL94V-0, GWT 750 °C
- Color:
(Blank): Ivory
BK: Black
RD: Red
BL: Blue
GN: Green
PK: Pink
LY: Lemon yellow

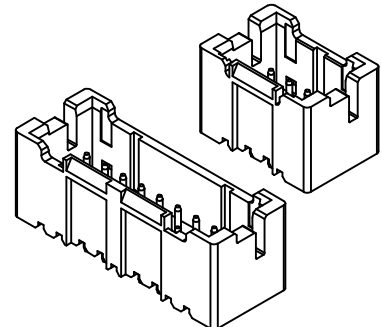
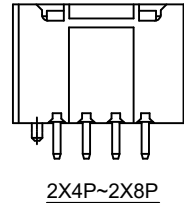
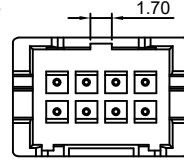
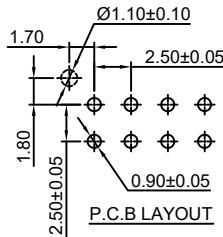
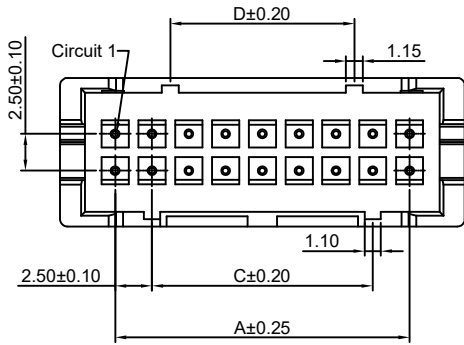

Ordering Information & Dimensions:

PART NO.	Dimensions			
	A	B	C	D
2x4P	7.50	14.70	9.10	----
2x5P	10.00	17.20	7.50	----
2x6P	12.50	19.70	10.00	----
2x7P	15.00	22.20	12.50	----
2x8P	17.50	24.70	15.00	----
2x9P	20.00	27.20	15.00	12.50
2x10P	22.50	29.70	17.50	15.00
2x11P	25.00	32.20	20.00	17.50
2x12P	27.50	34.70	22.50	20.00
2x13P	30.00	37.20	25.00	22.50
2x14P	32.50	39.70	27.50	25.00
2x15P	35.00	42.20	30.00	27.50
2x16P	37.50	44.70	32.50	30.00
2x17P	40.00	47.20	35.00	32.50
2x18P	42.50	49.70	37.50	35.00
2x19P	45.00	52.20	40.00	37.50
2x20P	47.50	54.70	42.50	40.00

Unit: mm

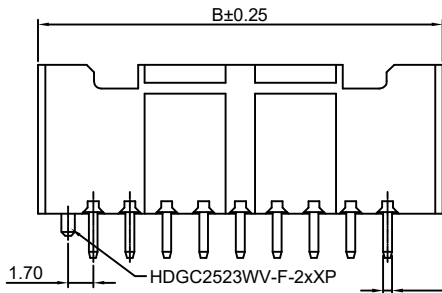

2X9P~2X21P

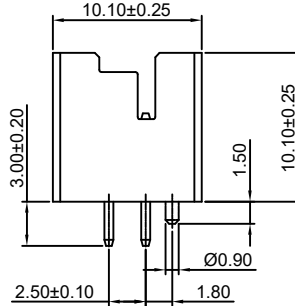

HDGC2523WR-F-2xXP

2.50mm Pitch Dual Row 90° Wafer

Reference Informations:

- *Material: Pin: Brass/Tin over Nickel
Insulator: Nylon 66, UL94V-0
- *Mates with HDGC2523H-2xXP series Housing
- *Color: Ivory

Ordering Information:
HDGC2523WR-F-2xXP - *** - **
1 2 3

- Part No.
- Material:
(blank): Nylon 66, UL94V-0
GWT: Nylon 66, UL94V-0, GWT 750 °C
- Color:
(Blank): Ivory
BK: Black
RD: Red
BL: Blue
GN: Green
PK: Pink
LY: Lemon yellow

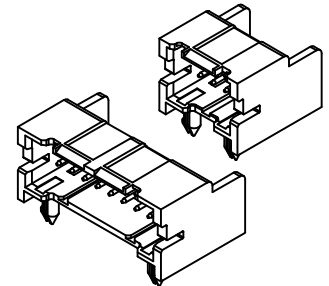
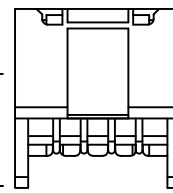
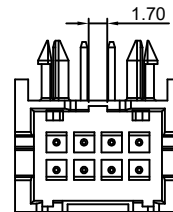
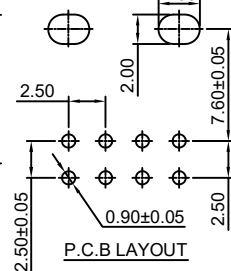
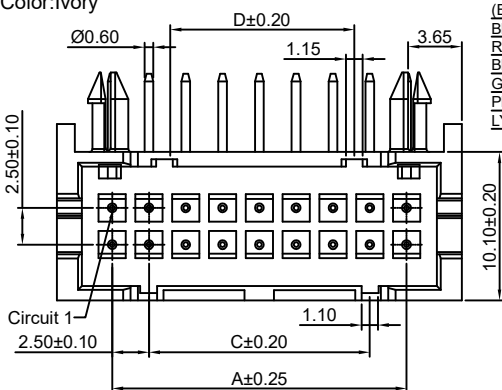

Ordering Information & Dimensions:

PART NO.	Dimensions			
	A	B	C	D
2x4P	7.50	14.70	9.10	----
2x5P	10.00	17.20	7.50	----
2x6P	12.50	19.70	10.00	----
2x7P	15.00	22.20	12.50	----
2x8P	17.50	24.70	15.00	----
2x9P	20.00	27.20	15.00	12.50
2x10P	22.50	29.70	17.50	15.00
2x11P	25.00	32.20	20.00	17.50
2x12P	27.50	34.70	22.50	20.00
2x13P	30.00	37.20	25.00	22.50
2x14P	32.50	39.70	27.50	25.00
2x15P	35.00	42.20	30.00	27.50
2x16P	37.50	44.70	32.50	30.00
2x17P	40.00	47.20	35.00	32.50
2x18P	42.50	49.70	37.50	35.00
2x19P	45.00	52.20	40.00	37.50
2x20P	47.50	54.70	42.50	40.00

Unit: mm

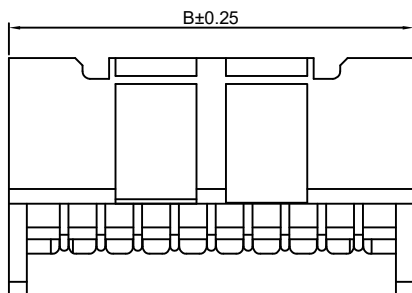

2X9P~2X21P

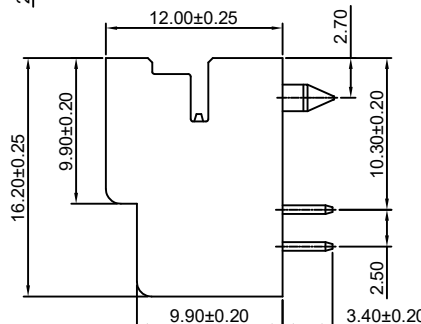



HDGC2523 Series 2.50mm (.098") Pitch Wire to Board and Wire to Wire Connector

HDGC2523WVA-2xXP

2.50mm Pitch Dual Row 180° Wafer

Reference Informations:

- *Material: Pin: Brass/Tin over Nickel
Insulator: Nylon 66, UL94V-0
- *Mates with HDGC2523HA-2xXP series Housing
- *Color: Beige

Ordering Information:
HDGC2523WVA-2xXP - *** - **
 1 2 3

1. Part No.
2. Material:
(blank): Nylon 66, UL94V-0
GWT: Nylon 66, UL94V-0, GWT 750 °C
3. Color:
(Blank): Beige
BK: Black
RD: Red
BL: Blue
GN: Green
PK: Pink
LY: Lemon yellow

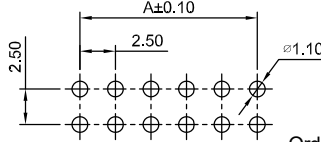
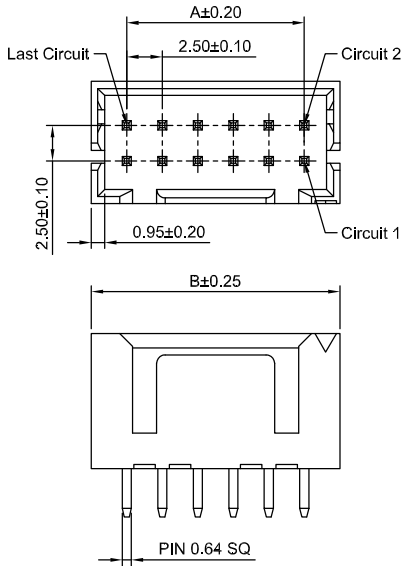
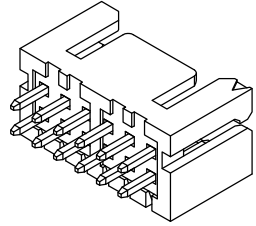

Ordering Information & Dimensions:

PART NO.	Dimensions	
	A	A
2x2P	2.50	7.50
2x3P	5.00	10.00
2x4P	7.50	12.50
2x5P	10.00	15.00
2x6P	12.50	17.50
2x7P	15.00	20.00
2x8P	17.50	22.50
2x9P	20.00	25.00
2x10P	22.50	27.50
2x11P	25.00	30.00
2x12P	27.50	32.50
2x13P	30.00	35.00
2x14P	32.50	37.50
2x15P	35.00	40.00
2x16P	37.50	42.50
2x17P	40.00	45.00
2x18P	42.50	47.50
2x19P	45.00	50.00
2x20P	47.50	52.50

Unit: mm

HDGC2523WRA-2xXP

2.50mm Pitch Dual Row 90° Wafer

Reference Informations:

- *Material: Pin: Brass/Tin over Nickel
Insulator: Nylon 66, UL94V-0
- *Mates with HDGC2523HA-2xXP series Housing
- *Color: Beige

Ordering Information:
HDGC2523WRA-2xXP - *** - **
 1 2 3

1. Part No.
2. Material:
(blank): Nylon 66, UL94V-0
GWT: Nylon 66, UL94V-0, GWT 750 °C
3. Color:
(Blank): Beige
BK: Black
RD: Red
BL: Blue
GN: Green
PK: Pink
LY: Lemon yellow

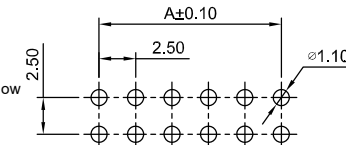
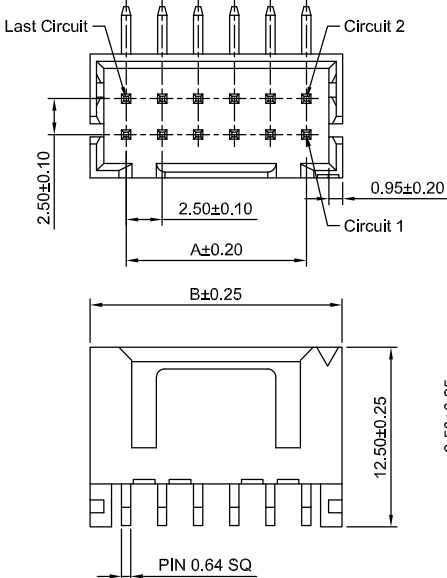
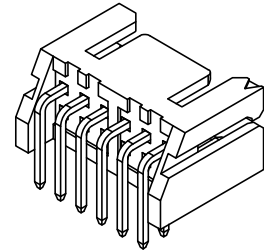

Ordering Information & Dimensions:

PART NO.	Dimensions	
	A	A
2x2P	2.50	7.50
2x3P	5.00	10.00
2x4P	7.50	12.50
2x5P	10.00	15.00
2x6P	12.50	17.50
2x7P	15.00	20.00
2x8P	17.50	22.50
2x9P	20.00	25.00
2x10P	22.50	27.50
2x11P	25.00	30.00
2x12P	27.50	32.50
2x13P	30.00	35.00
2x14P	32.50	37.50
2x15P	35.00	40.00
2x16P	37.50	42.50
2x17P	40.00	45.00
2x18P	42.50	47.50
2x19P	45.00	50.00
2x20P	47.50	52.50

Unit: mm



HDGC2523 Series 2.50mm (.098") Pitch Wire to Board and Wire to Wire Connector

HDGC2523WVT(-F)-XP

2.50mm pitch 180° Wafer ON RADIAL-TAPE

Reference Informations:

- *Material: Pin: Brass/Tin over Nickel
Insulator: Nylon 66, UL94V-0
- *Mates with HDGC2523H, HA-XP series Housing
- *Color: Ivory

Ordering Information:

HDGC2523WVT(-F)-XP - *** - ** - **
1 2 3 4

- Part No.
- Material:
(blank): Nylon 66, UL94V-0
GWT: Nylon 66, UL94V-0, GWT 750 °C
- Color:
(blank) : Ivory
BK : Black
RD : Red
BL : Blue
YL : Yellow
GN : Green
- Finish:
(blank): Tin over Nickel
G: Gold over Nickel

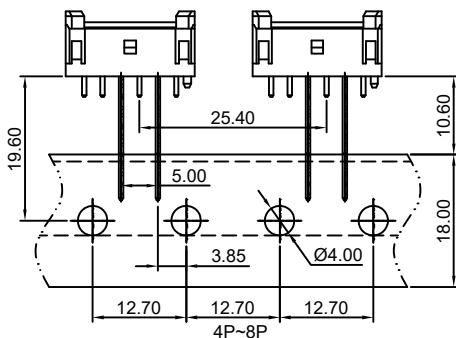
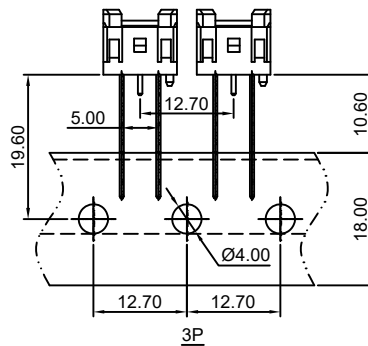
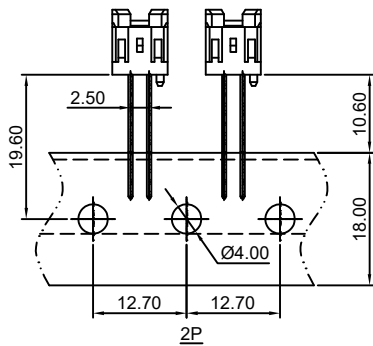
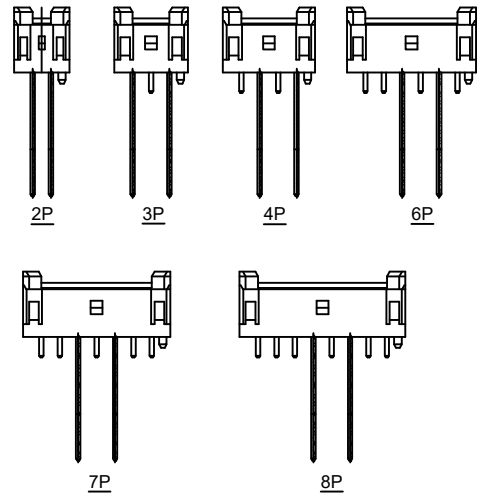
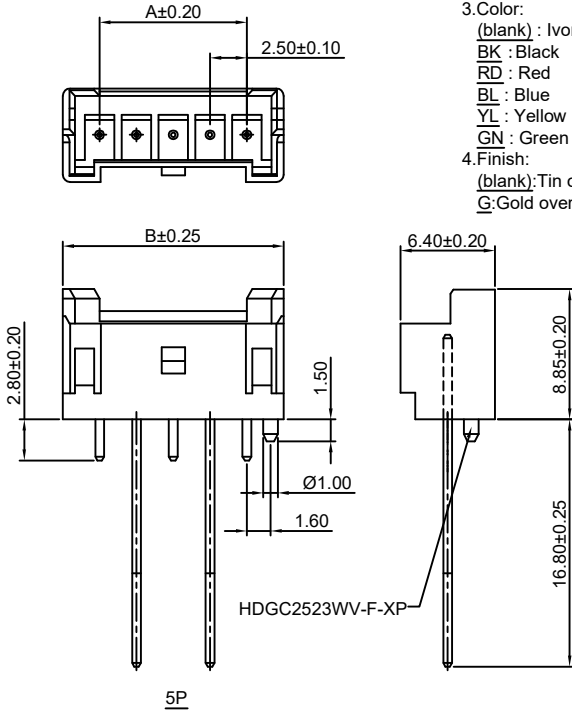
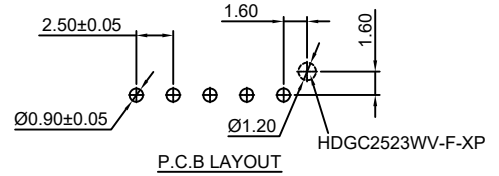

Ordering Information & Dimensions:

PART NO.	Dimensions	
	A	B
2P	2.50	7.50
3P	5.00	10.00
4P	7.50	12.50
5P	10.00	15.00
6P	12.50	17.50
7P	15.00	20.00
8P	17.50	22.50

Unit: mm



HDGC2523 Series 2.5mm (.098") Pitch Wire to Board and Wire to Wire Connector

HDGC2523WVT(-F)-XP-H

2.50mm pitch 180° Wafer ON RADIAL-TAPE

Reference Informations:

- *Material: Pin: Brass/Tin over Nickel
Insulator: Nylon 66, UL94V-0
- *Mates with HDGC2523H, HA-XP series Housing
- *Color: Ivory

Ordering Information:

HDGC2523WVT(-F)-XP-H - ^{***} - ^{**} - ^{**}

- Part No.
- Material:
(blank): Nylon 66, UL94V-0
GWT: Nylon 66, UL94V-0, GWT 750 °C
- Color:
(blank): Ivory
BK : Black
RD : Red
BL : Blue
YL : Yellow
GN : Green
- Finish:
(blank): Tin over Nickel
G: Gold over Nickel

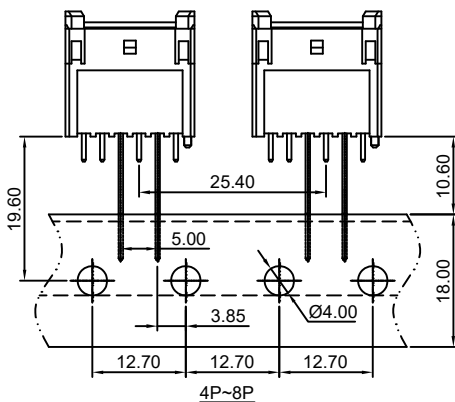
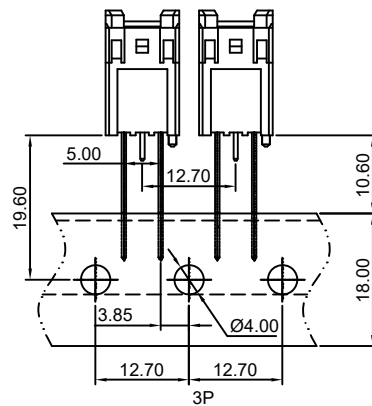
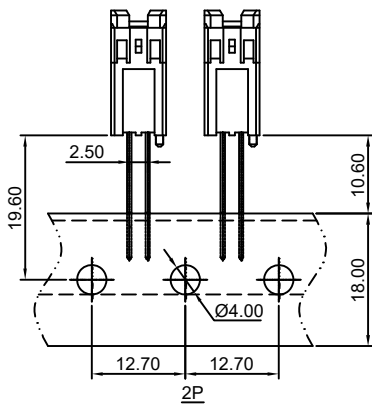
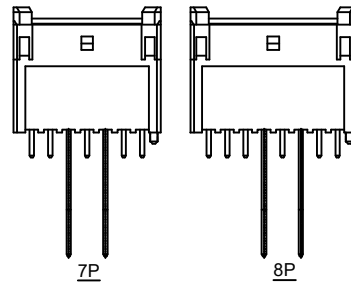
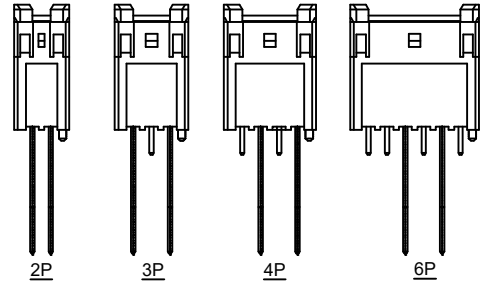
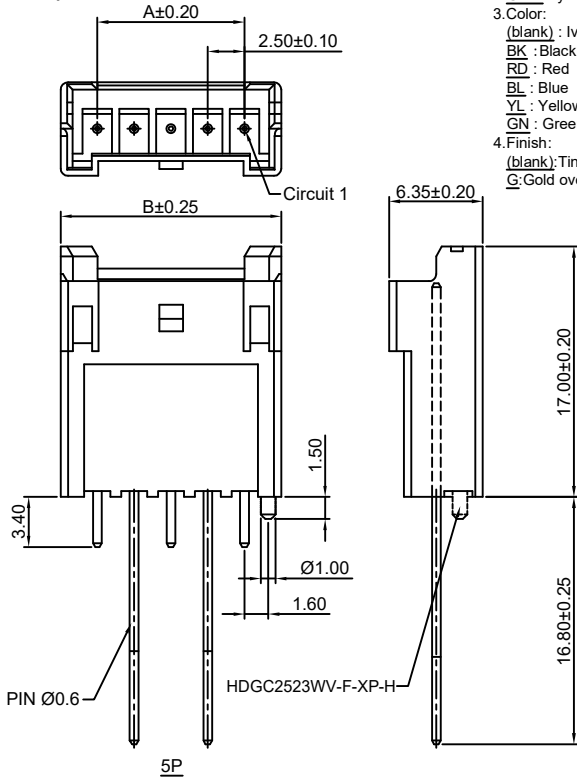
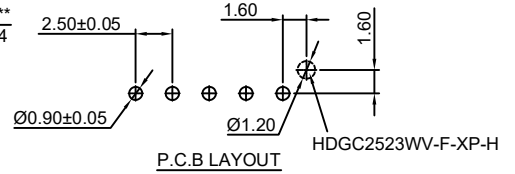

Ordering Information & Dimensions:

PART NO.	Dimensions	
	A	B
2P	2.50	7.50
3P	5.00	10.00
4P	7.50	12.50
5P	10.00	15.00
6P	12.50	17.50
7P	15.00	20.00
8P	17.50	22.50

Unit: mm