

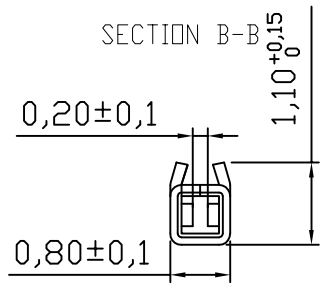

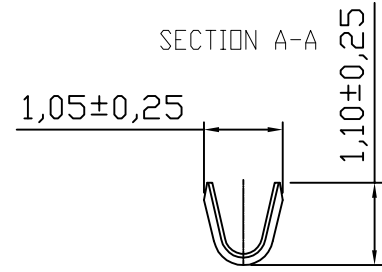

修订 REV	标记 MARK	修改摘要 REVISION DESCRIPTION	签名 SIGNATURE	日期 DATE
AO		NEW RELEASE	WANG	2013-05-07

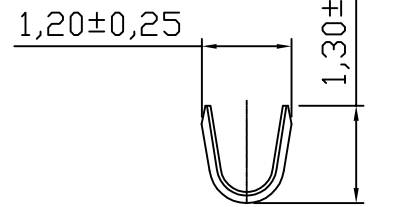

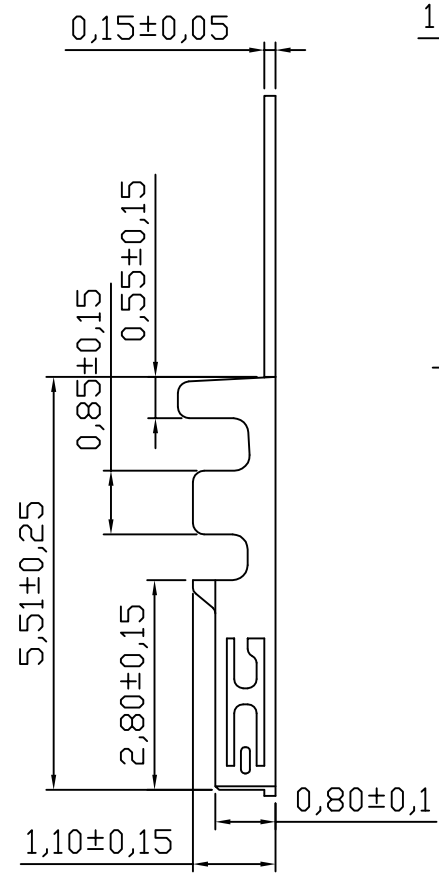
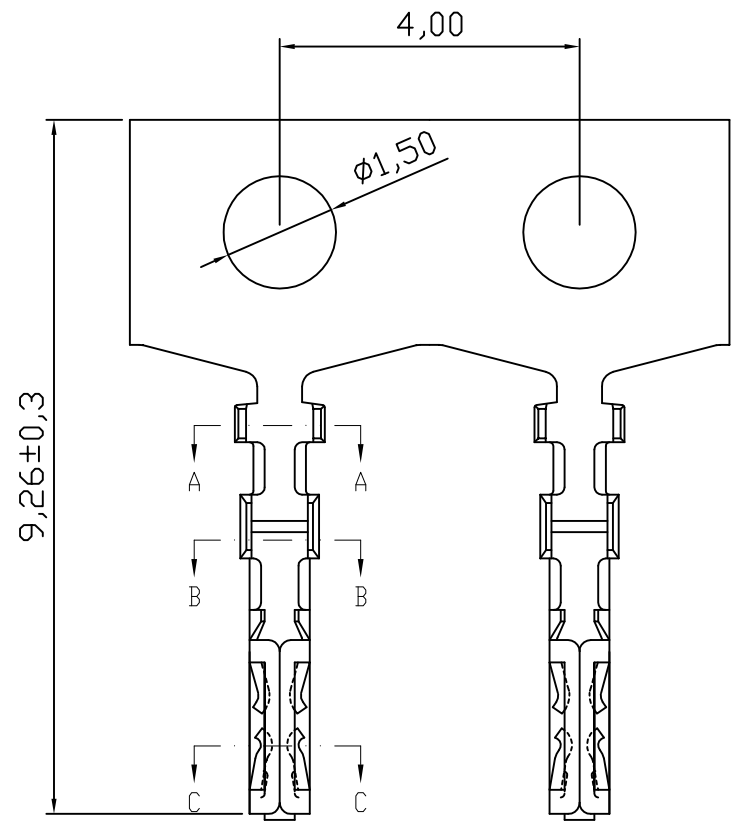

深圳市华德共创科技有限公司
 Shenzhen Huade co-create Technology Co.,LTD
 TEL : 0755-27129737 FAX : 0755-29940187

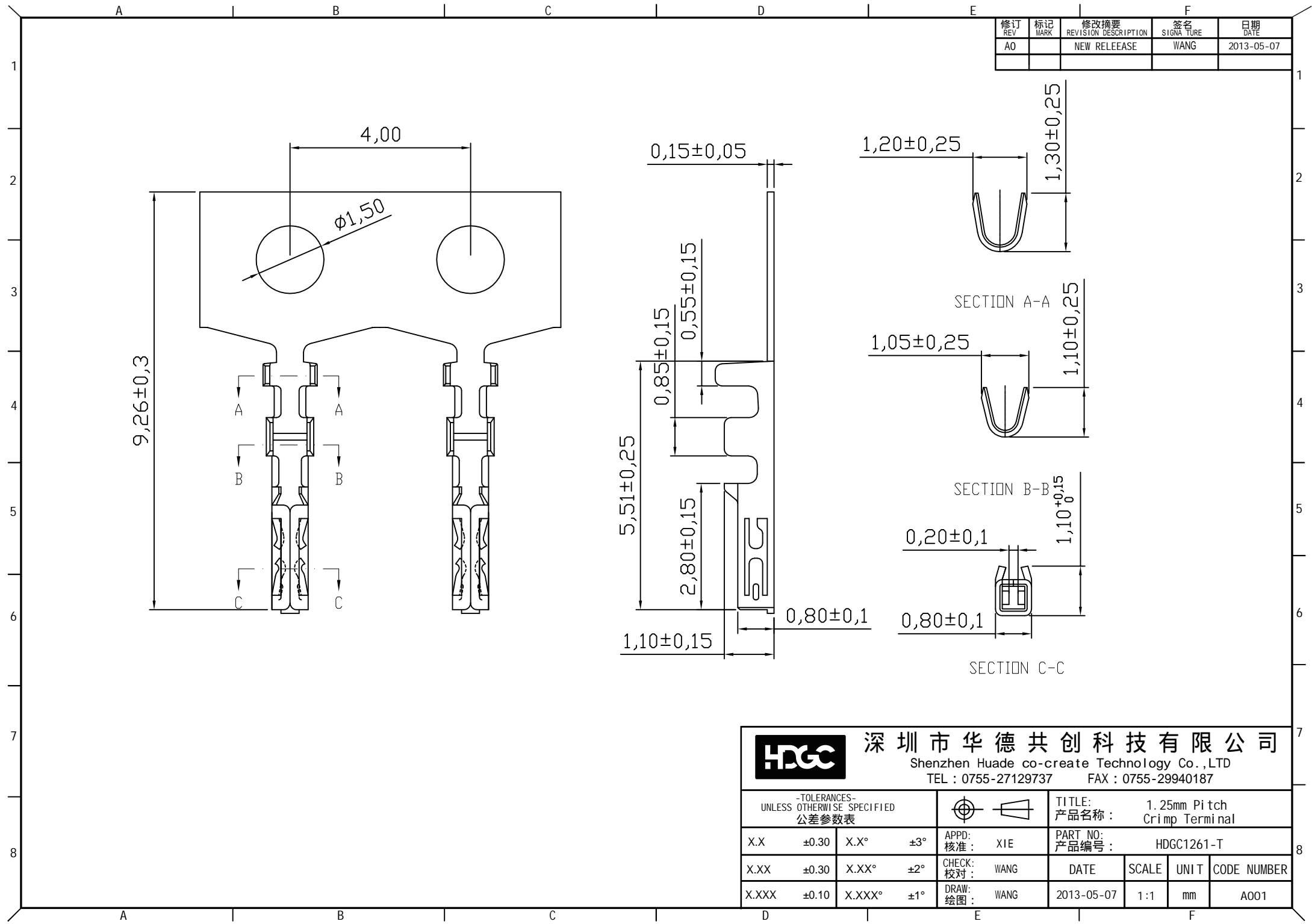

-TOLERANCES- UNLESS OTHERWISE SPECIFIED 公差参数表				 	TITLE: 1.25mm Pitch 产品名称: Crimp Terminal			
X.X	±0.30	X.X°	±3°	APPD: 核准:	XIE			
X.XX	±0.30	X.XX°	±2°	CHECK: 校对:	WANG			
X.XXX	±0.10	X.XXX°	±1°	DRAW: 绘图:	WANG			
				DATE	SCALE	UNIT	CODE NUMBER	
				2013-05-07	1:1	mm	A001	

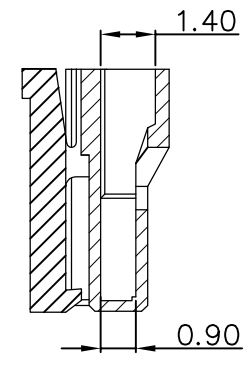
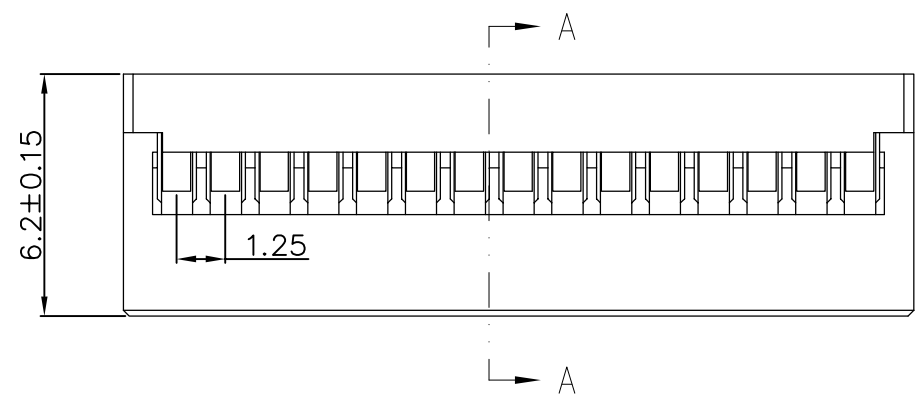
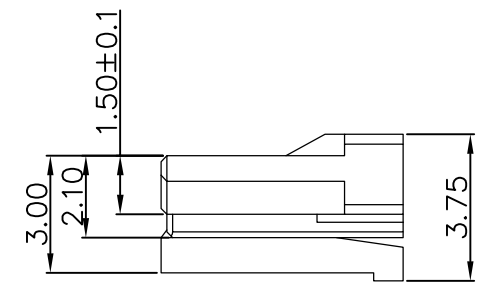
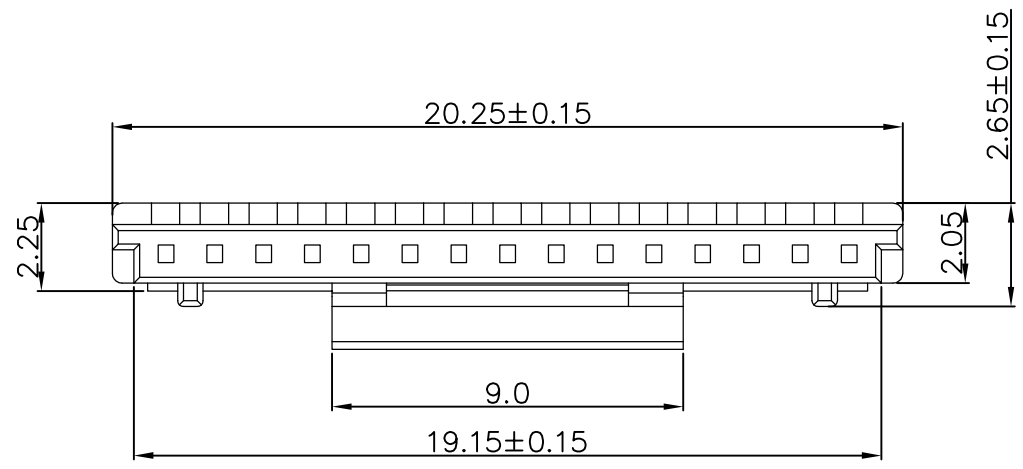

修订 REV	标记 MARK	修改摘要 REVISION DESCRIPTION	签名 SIGNATURE	日期 DATE
A0		NEW RELEASE	WANG	2013-05-07



SECTION A-A

		深圳市华德共创科技有限公司 Shenzhen Huade co-create Technology Co.,LTD TEL : 0755-27129737 FAX : 0755-29940187									
-TOLERANCES- UNLESS OTHERWISE SPECIFIED 公差参数表				 		TITLE: 产品名称 : 1.25mm Pitch Housing					
X.X	±0.30	X.X°	±3°	APPD: 核准 :	XIE			PART NO: 产品编号 :	HDGC1261H-15P		
X.XX	±0.30	X.XX°	±2°	CHECK: 校对 :	WANG			DATE	SCALE	UNIT	CODE NUMBER
X.XXX	±0.10	X.XXX°	±1°	DRAW: 绘图 :	WANG			2013-05-07	1:1	mm	A001